



Meets Standards:  
C22.2 no 113 and UL 1812



## INSTALLATION, OPERATIONS & MAINTENANCE MANUAL

# InspirAIR<sup>®</sup> Compact

## HEAT & ENERGY RECOVERY VENTILATORS

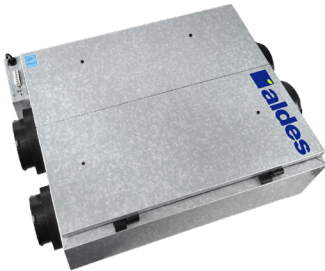

**FOR MODELS:**  
H/E80 • H/E130

### TO BE COMPLETED BY CONTRACTOR AFTER INSTALLATION

Installer: Leave this manual for the homeowner

\_\_\_\_\_

Model

\_\_\_\_\_

Installing Contractor

\_\_\_\_\_

Telephone / Contact

\_\_\_\_\_

Serial Number

\_\_\_\_\_

Installation Date

**REGISTER YOUR PRODUCT ONLINE AT ALDES-NA.COM**

## TABLE OF CONTENTS

I. INTRODUCTION	3
II. GENERAL HRV/ERV TERMINOLOGY & FUNCTION	3
Definitions	3
How Heat & Energy Recovery Ventilators Work	3
Ventilating with HRV/ERVs	4
III. PRECAUTIONS & GUIDELINES	5
Ducting Configurations	6
Locating the Air Exchanger	11
Ducting Materials	11
Connecting the Ducts	11
Vent Hood Locations	12
Locating the Exhaust Air Grilles or Registers	13
Locating the Air Grilles of Diffusers	13
Zone Register Terminals (ZRT®)	14
Humidity Control	14
IV. INSTALLATION	14
What's Included	15
Mounting the Unit	16
Drain Connections (HRV Models)	17
Electrical Diagram	18
Configuration Options	18
Unit Wiring	20
Wiring to the Power Source	23
Installing the Digital Multifunction Controller (P/N 611242-FC)	24
Installing the 20/40/60 Minute Timer (P/N 611228)	26
Installing the Speed Control (P/N 611229)	27
ZRT VentZone® Systems	28
V. MEASURING & BALANCING AIRFLOW	30
Measure and Balance	30
Door-Port Balancing	30
In-Duct Balancing	34
ZRT VentZone® Balancing	35
VI. MAINTENANCE	36
General Maintenance	37
Replacement Filters	38
Technical Assistance	38
Troubleshooting	39
VII. WARRANTY	41
What's Included	41
How to File a Warranty Claim	41

## I. INTRODUCTION

Thank you for purchasing this Aldes ventilation product. To receive the full benefit of your investment, we recommend that you read and retain this operating manual for future reference.

## II. GENERAL HRV/ERV TERMINOLOGY AND FUNCTION

### Definitions

**HRV (Heat Recovery Ventilator):** A ventilation device consisting of two fans and a heat recovery module to provide exhaust of stale indoor air, plus a balanced supply of fresh air, without mixing the two airstreams.

**ERV (Energy Recovery Ventilator):** This device is similar to the HRV, but differs only in that the core also transfers humidity from the more humid air stream to the less humid air stream.

### How Heat & Energy Recovery Ventilators Work

In the heating season, Aldes Heat Recovery Ventilators (HRV) and Energy Recovery Ventilators (ERV) draw in fresh air from outside. This air is distributed throughout the home by a dedicated-duct system or through the forced-air heating/air conditioning system. At the same time, vents located in moisture- and pollutant-producing rooms (e.g., kitchens, bathrooms, laundry rooms) exhaust an equal amount of stale, humid air to the outside. Sometimes air is drawn directly from the return air of a forced-air heating/air conditioning system.

As the two airstreams pass each other in the unit's core, the fresh air is tempered with heat recovered from the exhaust air. An ERV will also transfer moisture to the fresh air if this air is drier than the exhaust air, improving comfort in overly dry homes.

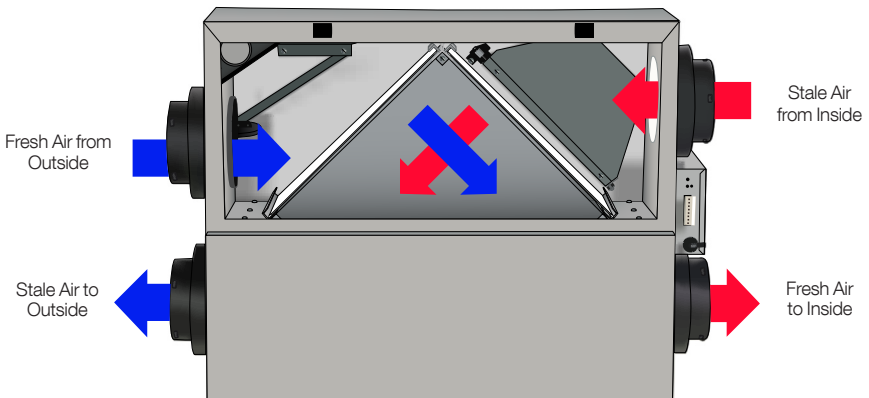



In the cooling season, the reverse occurs. Fresh outdoor air is cooled by the air-conditioned exhaust air. If the outgoing air is drier than the fresh air, the ERV will transfer moisture to the outgoing air. This process reduces the humidity load on the air conditioning system, which would otherwise result in the continuous introduction of humid summer air to the home.

***NOTE: It is important to understand that an ERV is not a dehumidifier by itself, but it will assist the air conditioner by removing much of the latent heat (water vapor) from the fresh air entering the home.***

## Ventilating with HRV/ERVs

Today's modern, tight homes require fresh outdoor air to maintain a healthy indoor air environment. The amount of ventilation you require in your home will depend upon:

- Number of occupants and their activity levels
- How your home was built
- Your personal preferences for fresh air

The Aldes HRV/ERV introduces fresh air to your home while recovering energy from the air it exhausts. Specifically, an HRV/ERV that is properly installed, operated and maintained will:

- Exhaust stale, contaminated air
- Recover the majority of the energy from the exhausted stale air
- Use the recovered energy to pre-heat or pre-cool outside air drawn into the house
- Distribute the fresh air throughout the house

During seasons when your windows and doors are closed (winter and summer if air conditioned), the HRV/ERV should be set to operate continuously on low speed with the option of going to high speed as the need arises. For example, if you are entertaining and many people are present, you should temporarily switch the unit to high speed.

You may wish to use an intermittent operational mode if your home is unoccupied for long periods.

### III. PRECAUTIONS & GUIDELINES

**WARNING** indicates the potential of risk of personal injury or death if not observed.

**CAUTION** identifies an action that may damage the unit, its components, or related equipment.

**RECOMMENDATIONS** and **NOTES** suggest operational modes, installation of vent hoods, interior supply and exhaust duct layouts, use of advanced features of the equipment that may result in improved economy and comfort.

**Installation and operation of these units must be in accordance with applicable local building and safety codes.**

#### **WARNING!**

**To avoid injury or damage to this unit, do not attempt to service any of the internal electrical or mechanical components. Your heat/energy recovery ventilator should be installed and serviced by a qualified heating and electrical contractor.**

#### **CAUTION**

**Before installation, careful consideration must be given to how this system will operate if connected to any other piece of mechanical equipment that operates at a higher static, i.e., a forced-air furnace or air handler. After installation, the compatibility of the two pieces of equipment must be confirmed by measuring the airflows of the HRV/ERV using the balancing procedure found in this manual.**

**NEVER install a ventilator in a situation where its normal operation, lack of operation, or partial failure may result in the backdrafting or improper functioning of vented combustion equipment.**

#### **WARNING!**

**TO REDUCE THE RISK OF FIRE, ELECTRIC SHOCK, OR INJURY TO PERSON(S) OBSERVE THE FOLLOWING:**

1. Use this unit only in the manner intended by the manufacturer. If you have questions, contact the manufacturer at the address or telephone number provided.
2. Before servicing or cleaning the unit, disconnect the power cord from the electrical outlet.
3. This unit is not designed to provide combustion and/or dilution air for fuel-burning appliances.
4. This unit is not designed to provide make-up air for other exhausting devices, such as range exhaust hoods, clothes dryers, or other exhaust fans.



5. When cutting or drilling into wall or ceiling structures, do not damage electrical wiring or other hidden utilities.
6. Do not use this unit with any speed controls, dehumidistats or timers other than those specifically indicated within this manual.
7. This unit must be grounded. The power supply cord has a three-prong grounding plug for your personal safety. It must be plugged into a mating 3-prong grounding receptacle, grounded in accordance with national and local codes. Do not remove the ground prong. Do not use an extension cord.
8. Do not install exhaust grilles in a cooking area (see "Locating the Exhaust Air Grilles or Registers" on page 13). Do not connect directly to any appliances.
9. Do not use to exhaust hazardous or explosive materials and vapors.
10. When performing installation, servicing or cleaning the unit, it is recommended to wear safety glasses and gloves.
11. When local regulations comprise more restrictive installation or certification requirements, such requirements supersede those in these instructions.

## CAUTION

1. This unit is intended for residential use only, conforming to the requirements of the International Residential, Building, and Mechanical Codes, NFPA 90B for the United States and the National Building Code of Canada.
2. Turn the unit off during construction to avoid clogging the filters and loading the blowers with construction dust.
3. Refer to the specification sheet for the specific model's dimensions, electrical requirements, drain connections, etc.
4. Ducting of stale air to the outdoors and fresh air from outdoors, must be terminated outdoors, not attics, crawl spaces, or attached garage.

## Ducting Configurations

The interior ducting system's purpose is to remove stale air and circulate fresh air to all habitable rooms. It is the responsibility of the installer to ensure all ductwork is sized and installed as designed to ensure the system will perform as intended.

The amount of air (CFM) that an HRV/ERV will deliver is directly related to the total external static pressure (ESP) of the system. Static pressure is a measure of resistance imposed on the blower by a length of ductwork plus the number of fittings used in the ductwork.

The following pages outline 3 duct configurations, from most desirable to least desirable.

**Note:** *These configurations are intended for typical residences. Applications such as greenhouses, atriums, swimming pools, saunas, etc., have unique ventilation requirements that should be addressed with an isolated ventilation system.*

**Fully Ducted System – Best Configuration**

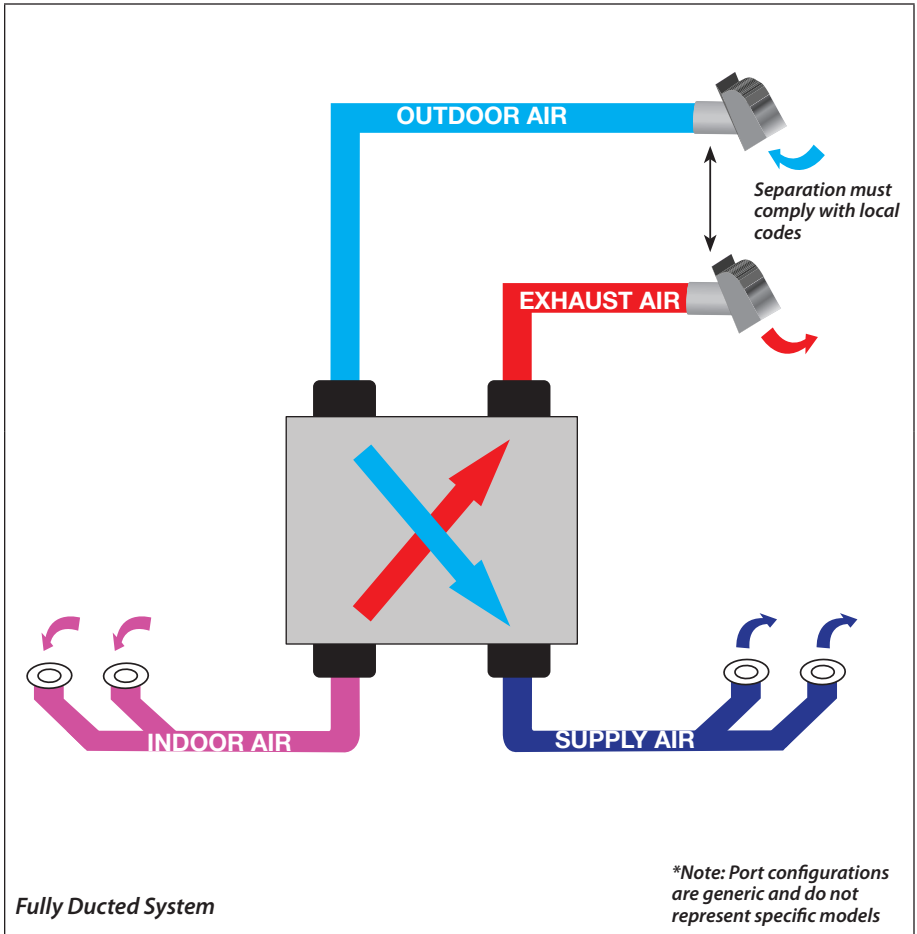

The **fully ducted system** has the highest ventilation effectiveness. It is especially suited for homes without forced-air systems used for both heating and cooling. Dedicated exhaust grilles draw stale air from service rooms. Dedicated supply registers provide fresh air to main living areas and bedrooms. Grilles should be located high on a wall or in the ceiling. Grilles that diffuse the air are recommended. Special care should be taken in locating grilles in the floor. Areas under baseboard heaters will help temper the air. See "Locating the Exhaust Air Grilles or Registers" page 13 and "Locating the Air Grilles or Diffusers" page 13 . Also refer to the installation instructions included with these products (sold separately).

This system is not connected to an Air-Handling Unit (AHU) or furnace. This system is normally balanced on high speed. If Aldes patented\* Zone Register Terminals (ZRT®) are used

for exhaust or supply registers, balancing must be done at normal operating speed.

**Partially Ducted System – Configuration**

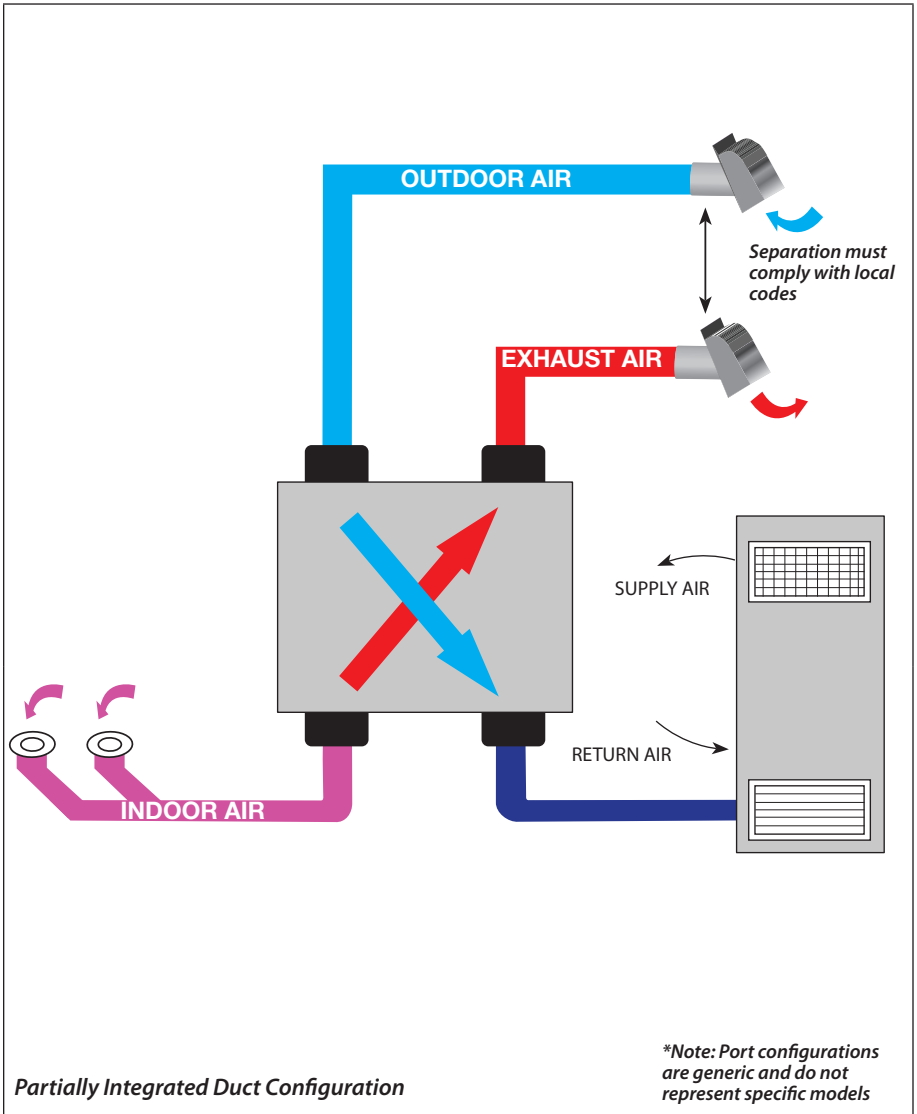



In a **partially ducted configuration**, individual exhaust grilles in bathrooms, laundry rooms, and kitchens draw stale air. Each location with a stale air duct could also have a timer that will initiate high-speed ventilation. Fresh air is distributed by the Air-Handling Unit (AHU) of a forced-air heating or air conditioning system. The connection to the forced-air system is typically to the return ducting or plenum of the AHU. See section “Interlocking the HRV/ERV to an Air-Handler/Furnace Blower” on page 18.

While this configuration is common in commercial installations, it is not always recommended for residences due to the following:

1. In this case, the AHU must run continuously or be interlocked to operate with the HRV/ERV to avoid loss of balanced supply and exhaust airflows.
2. In multi-speed AHU's, balancing must be conducted on the most frequently used speed, but the HRV/ERV may not remain in balance at other speeds.
3. In warm, humid seasons, continuous operation of the AHU causes evaporation from the cooling coil, resulting in a loss of humidity control. Failure to operate the AHU with the HRV/ERV may also result in condensation in the supply plenum and ducting.
4. Continuous operation of the AHU may cause drafts in the winter.
5. Backdraft or motorized dampers may be built into the HRV/ERV to prevent entry of outdoor air during off cycles, but they should not be installed in the duct leading to the outside.

Due to these reasons, it may be preferable to avoid a direct duct connection to the return of the AHU and use an **indirect approach** instead.

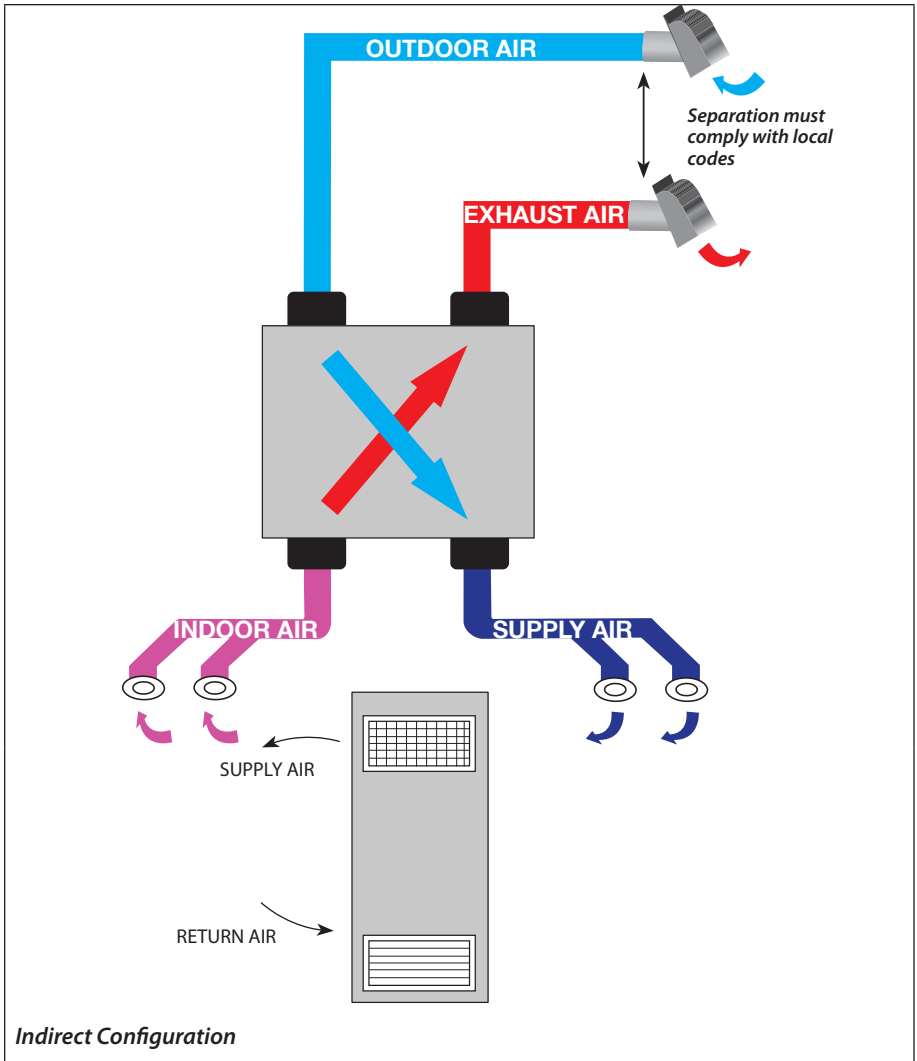

In this configuration, dedicated exhaust grilles remove stale air from bathrooms, laundry rooms, and kitchens. Fresh air is supplied to a large-volume room, such as a great room, family room, high stairway, etc. The forced-air system will draw the fresh air into the return grilles of the AHU and distribute it throughout the house. The HRV/ERV and AHU may operate independently with no impact on airflow balance.

A thermostat with a ventilation feature is recommended to turn on the AHU periodically to assure proper supply air distribution apart from heating/cooling cycles. This type of timer avoids the energy cost of operating the blower fan in the AHU, and it also lessens the concerns about draft in winter and re-evaporation from the AC coil in the summer.

## Locating the Air Exchanger

The device must be located in a place where the temperature is always above freezing. Choose a location for the device where the ducts will be short with minimal use of elbows. This ensures that the system functions optimally.

## Ducting Materials

1. Where ducting passes through concealed spaces (walls, ceiling-floor assemblies), the ducting should be metal to offer less resistance to airflow and permit duct cleaning.
2. Where the ducting remains permanently accessible, 5 to 10 feet of insulated flexible duct should be used between the HRV/ERV and all interior supply and exhaust registers to reduce fan noise passing the ducting to interior spaces.

## Connecting the Ducts

For the air exchanger to run optimally, place the ducts so they are as straight as possible. Ducts should be kept short and have as few bends or elbows as possible to maximize airflow. Forty-five degree elbows are preferred to 90-degree elbows. Use “Y” tees rather than straight tees whenever possible.

All ducts going through unheated areas must be insulated. The ducts between the exterior vent hoods and the HRV/ERV must be insulated and covered with a vapor barrier. See the next section “Vent Hood Locations”.

Flexible duct is recommended to provide vibration isolation between the unit and duct system. Start by determining the required duct length to reach each respective collar, and cut as required. If rigid duct is used, avoid attaching with screws to the duct collars, as they may interfere with the damper operations at each duct collar.

H80 and E80 models are equipped with twist-in collars to simplify the process of connecting flexible duct to your ventilator. Remove each duct collar by twisting them out of the locking tabs. Connect the ducts to the removed collars using duct tape and flexible duct straps. Reinstall collars, with duct attached, to their respective labeled ports on the HRV/ERV by lining up locking tabs and twisting on in a clockwise direction.

For H130 and E130 models, connect the ductwork to the collars on the unit using duct tape and flexible duct straps.



*\*Note: for illustration purposes only. Unit is not to be installed as shown.*

## Vent Hood Locations

(Manufacturer's recommendation only. Also consult Local Building Code Requirement.)

Wall hoods (sold separately) should be located where obstructions can easily be removed.

**Note: Please refer to Installation Instructions packaged with wall hoods.**

### Fresh Air (Intake) Wall hoods:

- Should be located upstream (if there are prevailing winds) from the exhaust wall hood
- At least 6 feet (2 metres) from the exhaust wall hood
- At least 6 feet (2 metres) from dryer vents and furnace exhaust (medium or high-efficiency furnaces)
- At least 6 feet (2 metres) from driveways, oil fill pipes, gas meters or garbage containers.
- At least 18 inches (457 mm) above the ground, or above the depth of expected snow accumulation.
- At least 3 feet (1 metre) from the corner of the building.
- Do not locate in a garage, attic, or crawl space.

### Exhaust Air Wall hoods:

- At least 6 feet (2 metres) from the fresh air intake wall hood.
- At least 18 inches (457 mm) above the ground, or above the depth of expected snow accumulation.
- At least 3 feet (1 metre) from the corner of the building.
- Not near a gas meter, electric meter, or a walkway where fog or ice could create a hazard
- Do not locate in a garage, workshop, or other unheated space.

Dual Intake and exhaust hoods: Concentric-type or dual intake/exhaust hoods may be used where authorized.

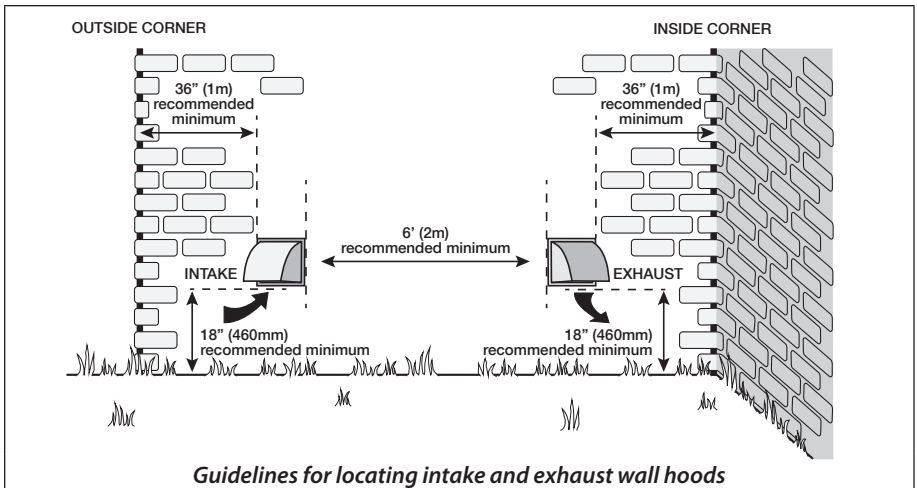

**Note: Local codes may allow less or require greater distances between exhaust and intake wall hoods.**

## Locating the Exhaust Air Grilles or Registers (in systems with dedicated exhaust ducting)

The exchanger has at least one exhaust air intake register. Exhaust air registers should be placed where the humidity level is high, such as bathrooms, laundry rooms, and kitchens. However, do not install in areas of extreme humidity such as steam showers, jacuzzi rooms, indoor pools and solariums. Kitchen exhaust grilles must never be connected to the range hood. Do not install an exhaust grille ducted to the HRV/ERV in a cooking area, defined by the area above or inside a 45-degree angle projected outwards from the cooking element closest to the exhaust grille. See figure below.

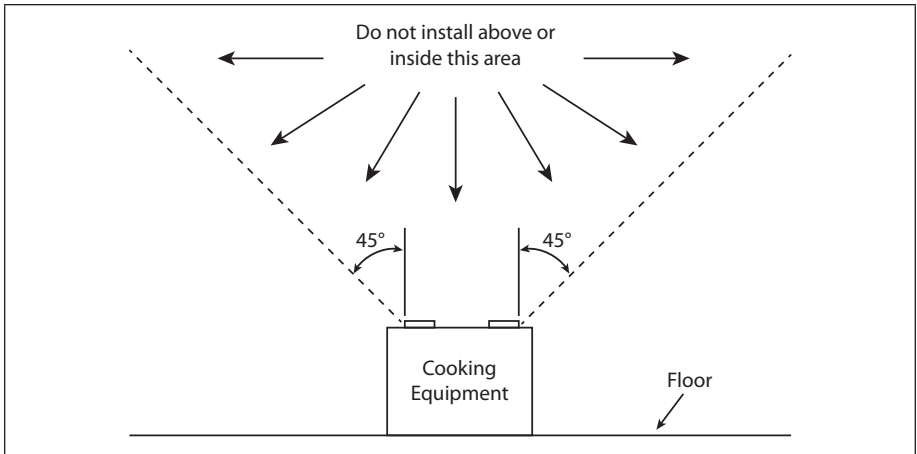

Normally, the exhaust air intake register would be located on the first floor between the bathroom and the kitchen, or in the basement near the bathroom. Avoid placing it in the same room as a combustion device, such as a fireplace or furnace. The vent should be installed high on the wall or in the ceiling. If installed on the wall, it should be placed at least 12 inches (30 cm) from the ceiling.

Adjustable grilles can be used to balance the flow rates. Field supplied balancing dampers can be external to the unit to balance the amount of stale air being exhausted. These grilles should not be adjusted after balancing the unit.

## Locating the Supply Air Grilles or Diffusers

The fresh air diffusers should be installed in hallways, near the primary return for the forced air system, in bedrooms and/or in common living areas. Diffusers should be located a reasonable distance from the exhaust registers to promote circulation of the fresh air throughout the dwelling. The supply diffusers should be installed high on the wall or in the ceiling. If the diffuser is located in a common area, it is recommended to place it on the ceiling so that it can better mix with the air in the room before reaching occupants. This will improve comfort in cold weather. If diffusers are installed on the wall, place them at least 12 inches (30 cm) from the ceiling.

Adjustable grilles can be used to balance the flow rates. Field supplied balancing dampers can be external to the unit to balance the amount of fresh air being supplied relative to the other diffusers. These grilles should not be adjusted after balancing the unit.

### Zone Register Terminals (ZRT®)

Aldes patented\* Exhaust Zone Register Terminals (ZRT®) are designed to introduce flexibility and on-demand control to central ventilation systems. Used in both large and small systems, the ZRT zonally regulates ventilation without the need for individual fans. Each ZRT is a combination grille, register box, control damper, and optional flow regulator(s). This unique combination provides up to four different control schemes without the need for expensive pneumatic, electronic, or DDC control systems.

By replacing static grilles in large central exhaust systems, the ZRT-1 model provides on-off control for on-demand ventilation. The optional Constant Airflow Regulator can be installed in the ZRT-1's extended duct collar to place a maximum flow limit on each terminal. The ZRT-1 does not work well when continuous low ventilation is needed; therefore using the ZRT-1 in a location such as a half bath is the best application of use.



ZRT-1

The ZRT-2 model can be used for combination low-flow indoor air quality ventilation and on-demand high-flow spot ventilation using the same central fan system. This is achieved by integrating a minimum Constant Airflow Regulator directly into the damper sub-assembly. With the damper completely closed, the factory-calibrated will still allow steady, low-continuous ventilation during fan operation. When other ZRTs are opened for on-demand control of spot ventilation, the closed ZRT-2 will maintain the specified low-continuous rate through the minimum constant airflow regulators. By opening the ZRT-2's control damper, the low-flow is removed from the air stream, allowing either controlled (optional using a second) or full maximum-boost ventilation. Using the ZRT-2 in a location such as a full bathroom is the best application of use.

### Humidity Control

Tight, well-insulated space may have high indoor humidity levels during the heating season. High humidity will be apparent from visible condensation on windows. The amount of window condensation will increase as outdoor temperatures drop. On summer nights, the outside air is often cooler than the air inside your home.

Your HRV/ERV will reduce indoor humidity levels when outdoor air is drier than indoor air. This usually occurs during the heating season when outdoor temperatures are less than 59°F (15°C), as shown in the following table:

RECOMMENDED RELATIVE HUMIDITY TO PREVENT INDOOR CONDENSATION*	
OUTSIDE AIR TEMPERATURE	RELATIVE HUMIDITY
0°C to 10°C (32°F to 50°F)	45% - 50%
-6°C to 0°C (21°F to 32°F)	40% - 45%
-12°C to -6°C (10°F to 21°F)	35% - 40%
-18°C to -12°C (0°F to 10°F)	25% - 30%
-24°C to -18°C (-11°F to 0°F)	20% - 25%
Under -24°C (-11°F)	Under 20%

\*Values according to the type of construction and fenestration of your house.

ASHRAE 62.2 standards recommend maintaining a relative humidity rate between 30% and 60%. The average person is comfortable between 30-50% relative humidity (RH).

*Aldes offers several wall controls with a dehumidistat function. Please refer to the wall control user guide for detailed information.*

## IV. INSTALLATION

### What's Included

Verify that all parts have been included with the shipment. If any parts are missing, notify your distributor as soon as possible. **Note: Quantity of parts may vary depending on model of air exchanger (e.g., single or double drain)**

- Heat or Energy Recovery Ventilator
- User manual
- Parts Bag
  - » (4) - springs
  - » (4) - hooks
  - » (8) - sheet-metal screws for hooks
  - » (4) - wood screws for hooks
  - » (4) - Assembly chains
  - » Drain tubing (H80 and H130 models only)

The following are typical items (sold separately) that may be used for standard installation. Contact your local distributor to order Aldes items.

- » Ceiling mount bracket for H/E80 (P/N 609419)
- » Ceiling mount bracket for H/E130 (P/N 609418)
- » Digital Multifunction Controller (P/N 611242-FC) (required to enable free cooling)
- » Electronic humidistat with LCD (P/N 611227)
- » 20/40/60 Minute Timer (P/N 611228)
- » Speed Control (P/N 611229)
- » Mode Control (P/N 611230)
- » Interior exhaust grilles
- » Supply diffusers
- » Sleeves or register boxes for interior supply and exhaust
- » Exterior wall hoods for supply and exhaust
- » Insulated duct
- » Uninsulated duct
- » MR Modulo (constant airflow regulators)

## Mounting the units

### Mounting the units using chains

To suspend the device using the supplied chains, affix the four mounting brackets to the upper corners of the unit. Then, using the chains and the springs, suspend the air exchanger from the joists.

### Mounting the units using a ceiling bracket (sold separately)

It is highly recommended to refer to the detailed installation instructions that are provided with the ceiling bracket kit.

Assemble the ceiling bracket, place the antivibration grommets and affix to the ceiling with appropriate fasteners. Next, attach the provided mounting brackets to the corners of the unit. Lift the end of the unit with the hooked brackets to the ceiling bracket and attach, then raise the other side of the unit until it snaps into place. Finally, use the two security screws to fix the unit to the ceiling bracket.

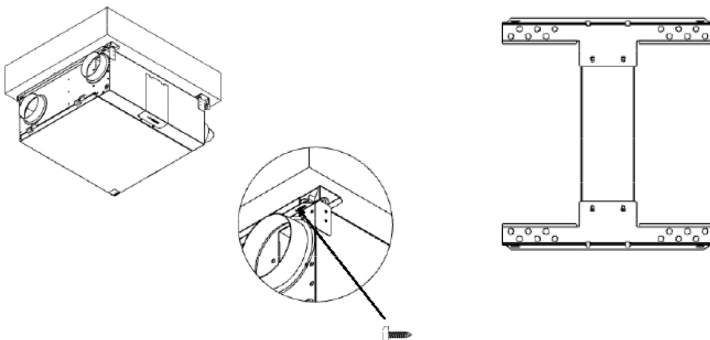



### Drain Connections (HRV Models only ERV Models do not require plumbing.)

Regardless of mounting method, the device should be installed level to ensure that condensation (produced during a defrost cycle) drains from the unit. The water should flow into a nearby drain or bucket.

**CAUTION:** HRV must be installed level to ensure proper condensate drainage. Due to the broad range of installation and operation conditions, consider the possibility of condensation forming on either the unit or connecting ducting. Objects below the installation may be exposed to condensate.

The HRV has two pre-punched holes for the drain. Insert the drain spout through the hole in the drain pan. Be sure to install the "O ring" to seal each spout to the pan. Hand tighten the washer and lock nut that holds the drain spout in place.

Construct a P-Trap using the plastic tee connector. Cut two lengths of drain hose and connect the other ends to the two drain spouts. Position the "T" fitting to point upward and connect the drain line. Tape or fasten the base to avoid kinks.

Connect the drain hoses to the building's drainage system, as shown in the following diagrams. No hard pipe connections to the unit.

After the drain connection is complete, pour a cup of water into the drain pan of the unit. This creates a water seal that will prevent odors from being drawn up the hose and into the fresh air supply of the HRV.

**CAUTION:** Drain trap and tubing MUST be below bottom of door with 1/4" per foot downwards slope away from the unit.

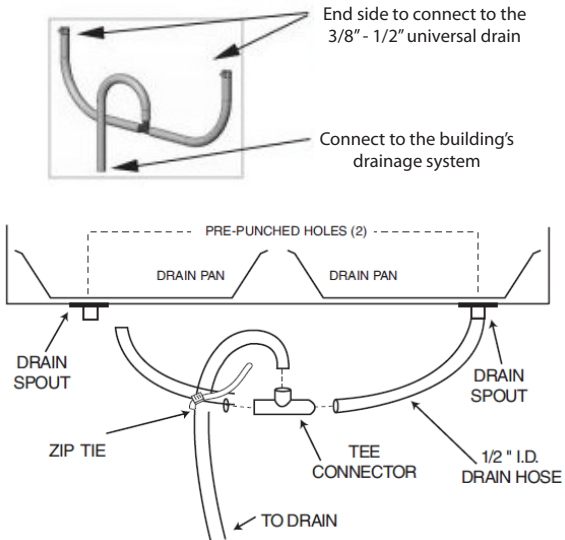

### Electrical Diagram

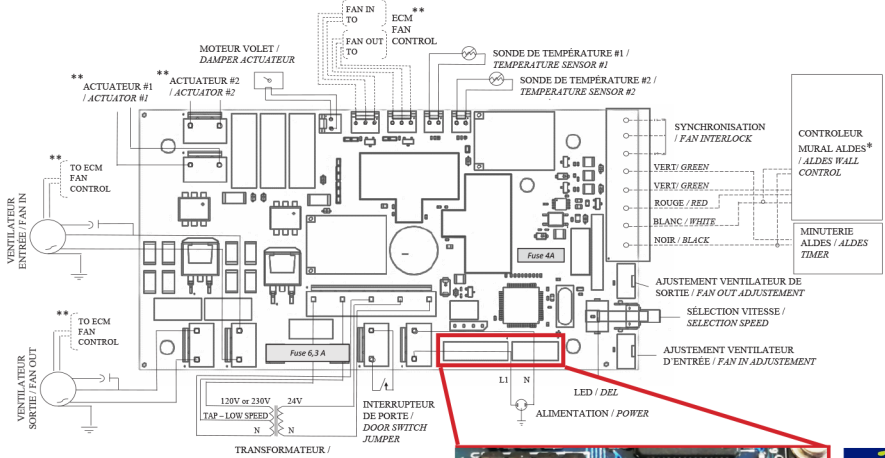

\*Refer to the user guide for Aldes wall control installations  
 \*\* Optional      \*\*\* Fuses 6,3A and 4A are replaceables

Extra jumper (does not connect both pins).  
 Option is selected when jumper connects both pins on the row.

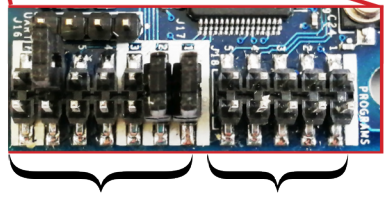

### Configuration Options

In order to configure the different modes on your unit, you may need to move a jumper on the unit's printed circuit board. This can be done without any special tools following the directions below.

**Suggestion:** it is easiest to do this prior to installation, on a table with the unit on its back.

1. Disconnect the unit power cable to avoid electric shock or damaging the PCB.
2. Remove the unit's terminal block by firmly pulling it straight out.

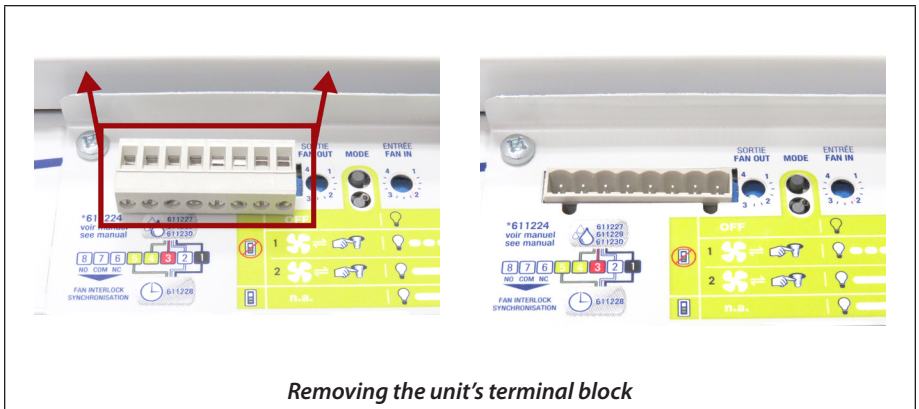

Removing the unit's terminal block

3. Using a Phillips head screwdriver, remove the three screws that secure the metal control

board cover.

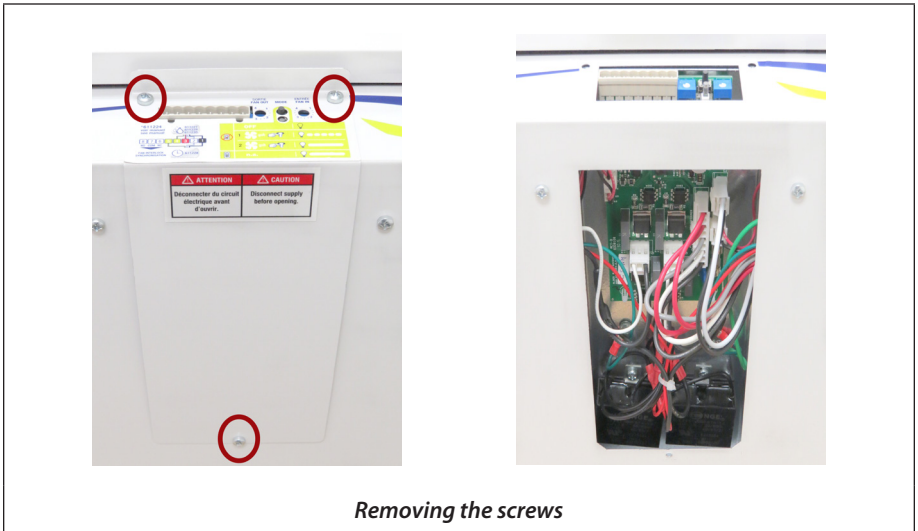

4. With the cover removed, locate the jumper pins on the control board. These are positioned just behind the motor speed dials on the front of the unit. In the next few pages, you will find how to set the jumpers to enable or disable your options.
5. In order to configure the different modes available for the unit, you will need to move different jumpers in the Options jumper block. It is the block with jumper pins ranging from 1 through 7. Below are the configurations for the different options available.

5a) Defrost modes

- » By default, the HRV/ERV is configured for **Normal Defrost**, with no jumpers on pin sets 5 and 6. Normal Defrost is optimized for most climate zones. The unit will automatically protect the core from frost build up by periodically switching to high speed recirculation or exhaust.
- » For extremely cold climates, you can choose the **Extended Defrost** option which increases the time in which the unit stays in the defrost cycle. To activate the Extended Defrost option, position a jumper on the configuration port 6 and make sure it connects both pins in the row.

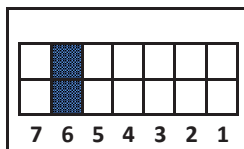

- » The **Comfort Defrost** option prevents the HRV/ERV from switching from low to high speed and back during defrost cycles, so there will be no audible difference

between exchange and defrost. To activate Comfort Defrost, position a jumper on the configuration port 5 and make sure it connects both pins in the row.

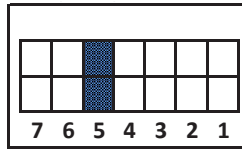

- » **Note that the Extended and Comfort Defrost settings can not be activated at the same time.** This means there should never be jumpers on both configuration ports 5 and 6.

#### 5b) Slave mode

- » In slave mode, an external device (e.g. air handler) or switch will determine when the HRV/ERV will operate.
- » By default, the slave mode option is DISABLED.
- » To activate slave mode, position a jumper on the configuration port 7 and make sure it connects both pins in the row.

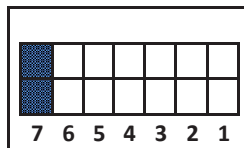

6. Once configuration is complete, replace the circuit board cover and the terminal block and proceed to wiring the unit to the controls.

## Unit Wiring

### A) Unit wiring to accessories

All units can be used with the following Aldes wall accessories:

- 611227: Electronic Humidistat with liquid crystal display
- 611229: Speed Control
- 611230: Mode Control
- 611242-FC: Digital Multifunction Wall Control

These can all be used on their own or with a timer (611228). To wire an accessory and/or a timer, connect the HRV/ERV as illustrated on the right.

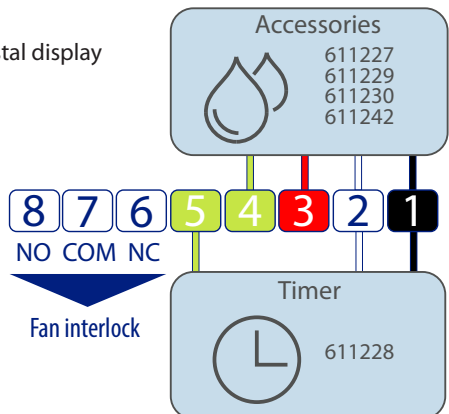

With this wiring, the unit can be operated at the following settings:

- Off
- Low Speed Exchange
- High Speed Exchange
- Low Speed Recirculation (except for models H/E110-TF)
- High Speed Recirculation (except for models H/E110-TF)

Low and High speeds can be adjusted with FlexControl (refer to page 32).

### B) Unit wiring for Slave Mode

In slave mode, an external device or switch will dictate when the unit will operate. This is the case for VentZone® Systems, use of third party thermostats with built in HRV/ERV controls, and use of external third party switches that are used to enable/disable the unit. Installations requiring a switch to enable or disable the unit via a wall switch will need to be placed into slave mode.

To enable low speed exchange, a connection must be made between terminals 1 and 3 (see illustration below). If this connection is open, the HRV/ERV will be put into standby mode. This connection can be made using any 24V switch or dry contact controller, such as a smart thermostat with integrated ventilator control or a programmable timer.

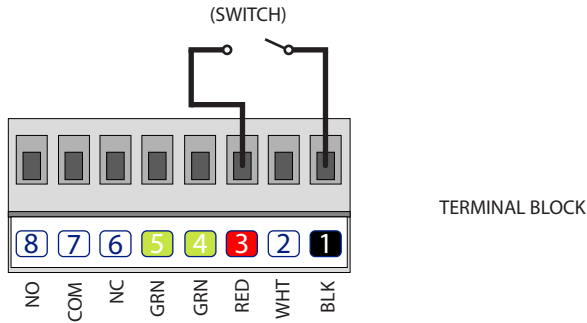

#### *Slave Mode - Enabling Low Speed*

If low speed is insufficient and high speed is required to satisfy the ventilation rate, connect a jumper between terminals 3 and 4 in addition to the switched line between terminals 1 and 4 (see illustration below). This sets the ventilation speed to high.

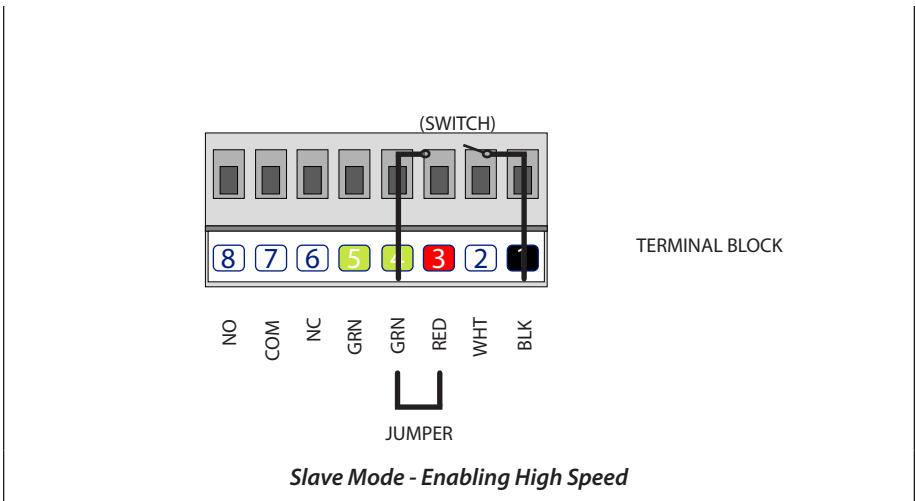

### C) Interlocking the HRV/ERV to an Air-Handler/Furnace Blower

Installations sharing ductwork with air-handling units or furnaces operate most effectively when those units are powered on to properly distribute the fresh air provided by the ventilator throughout the home. The HRV/ERV has the ability to interlock with external equipment, such as an air-handler or furnace blower, to activate or deactivate that equipment as necessary.

The unit's terminal strip has two fan interlock options via terminals 6, 7, and 8 on the terminal block. Terminal 6 is NORMALLY CLOSED, and terminal 8 is NORMALLY OPEN. Terminal 7 is the ground for both 6 and 8.

For the HRV/ERV to operate only in conjunction with the Air-Handler/Furnace, do the following:

1. Connect the HRV/ERV as illustrated below. Refer to the AHU Owner's Manual/Wiring Diagram for instructions on connecting to the fan start relay.

**Note: It is the same process as connecting the fan control on a thermostat.**

2. Ensure the air-handler/furnace blower motor is operating whenever the HRV/ERV is ventilating.

**Note: Consideration must be given to competing airflows when connecting the HRV/ERV in conjunction with an Air-Handler/Furnace Blower system.**

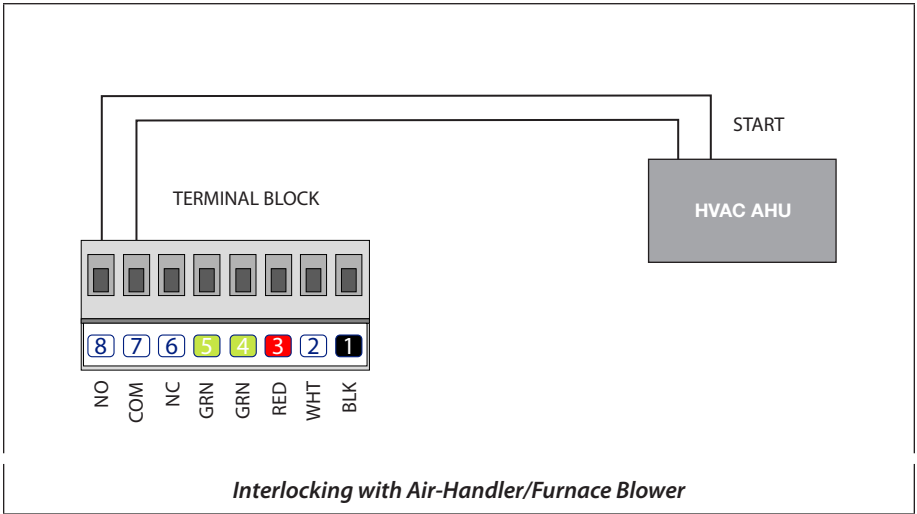

## Wiring to the Power Source

Once all the ducts are installed and the wires for the controllers are connected, connect the HRV/ERV to a 120V power source according to the model type:

### Models with power cord and NEMA 5-20 plug:

Plug the HRV/ERV into a standard 120V NEMA 5-20 receptacle with ground. **DO NOT USE AN EXTENSION CORD.**

### Models without power cord (model numbers ending in -N):

**WARNING:** Cordless models must be wired to the building mains by a licensed electrician according to applicable electrical and building codes.

To wire the HRV/ERV:

1. Ensure that the circuit breaker is turned off during installation.
2. Locate the junction box on the HRV/ERV (see illustration below).
3. Remove the junction box cover with a Philips-head screwdriver. Retain the screws for later when replacing and securing the junction box cover (Step 7).
4. Insert the electrical conduit into the 7/8" (22.3 mm) hole in the junction box cover, and secure it with a clamp or washer and screw.
5. Pass the wire through the conduit.
6. Strip insulation 1/4" (6.4 mm) from the ends of the wires.
7. Connect the wires to the HRV/ERV terminal block
8. Replace the junction box cover over the box and secure it using the screws from Step 2.
9. Turn on the circuit breaker and confirm that the HRV/ERV powers up.

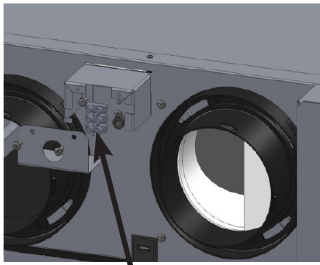

*Location of junction box  
on H/E80 models*

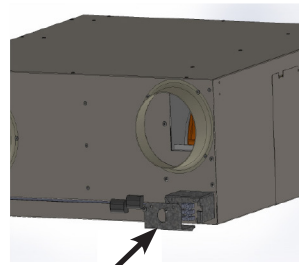

*Location of junction box  
on H/E130 models*

### Installing the Digital Multifunction Control (P/N 611242-FC)

The Digital Multifunction Controller is an advanced wall control that offers the user many different ways of operating the HRV/ERV, including an Automatic mode that uses a high-accuracy, fast response humidity sensor to remove excess humidity from the home.

The Digital Multifunction Control (P/N 611242-FC) can be used with any type of Aldes Residential HRV/ERV. The controller should be installed in the place where excess humidity is most likely to be detected, for example near a bathroom, kitchen or in the basement. Ensure good air circulation around the controller. Do not place it behind a door, for example.



Multifunction Control  
(P/N 611242-FC)

Please refer to the controller's documentation for detailed mounting and operating instructions. Note that the Automatic dehumidistat mode is intended to be used when the outdoor air has less moisture content than the indoor air. Turn off the Automatic mode when outdoor air is hot and humid.

### Free Cooling (E80-HRG and E80-HRX only)

This setting is to take advantage of the automatic Free Cooling mode available on certain Aldes air exchangers. If the indoor temperature exceeds 22°C (72°F) and the outdoor temperature is between 13°C and 19°C (55°F and 66°F), Free Cooling brings in the fresh air directly, without exchanging heat from the indoor air. This lowers the temperature of the indoor air more quickly, reducing the need for air conditioning.

1. To activate or deactivate the Free Cooling mode of the HRV, press the UP and DOWN arrow keys together for 2 seconds.
2. The alphanumeric characters indicate the transition to the active state «On» or inactive state «Off» of the Free Cooling mode on the HRV. When the Free Cooling mode is activated, the symbol ❄️ appears; NOTE: Even if the Free Cooling symbol ❄️ appears on the screen, it takes specific indoor and outdoor temperature conditions (described above) for the ventilator to actually operate in the Free Cooling mode.



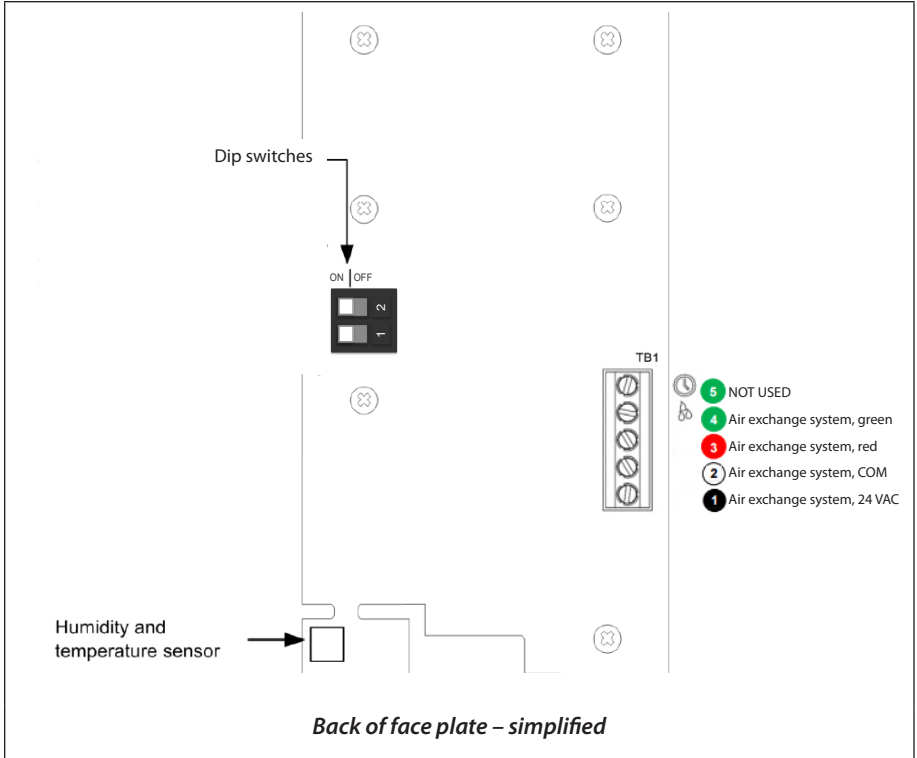

**CAUTION:** Turn off power to avoid risk of malfunction.

To connect the Digital Multifunction Control to the HRV/ERV, follow these diagrams:





















Set the ON/OFF switches to correspond to your HRV/ERV model, as listed in the following table:

 <p><b><u>With recirculation and without free cooling</u></b> Models: H/E80-HR, H/E130-HR(G), E130-HRX</p>	 <p><b><u>Without recirculation</u></b> Models: H/E80-HF, E130-HF</p>
 <p><b><u>With recirculation and with free cooling</u></b> Models: E80-HRG, E80-HRX</p>	

Connect each wire to the terminal board on the back of the controller face plate according to the connection chart shown on the mounting plate. Then connect the 4-conductor wire to the terminal board on the HRV/ERV according to the respective colors. The control operates at 24V.

The following table shows which operating modes are available for the different ON/OFF settings:

Mode	Speed	Description	 ON   I OFF 0 ON   ON	 ON   I OFF 0 OFF   ON	 ON   I OFF 0 ON   OFF	 ON   I OFF 0 OFF   OFF
OFF	--	Unit stops completely. Remains idle regardless of the humidity level.	Yes	Yes	Yes	Yes
	 0	Remains idle until the humidity goes above the setpoint.	Yes	Yes	-	-
	 1	Continuously exchanges air with the outside at low speed.	Yes	Yes	Yes	Yes
	 2	Continuously exchanges air with the outside at high speed.	Yes	Yes	Yes	Yes
	 1	Recirculates interior air at low speed.	Yes	No	Yes	Yes
	 2	Recirculates interior air at high speed.	Yes	No	Yes	Yes
ECO-1	 1	Exchanges air for the first 20 minutes, followed by recirculation for 40 minutes. Repeats every 60 minutes.	Yes	No	Yes	Yes
ECO-2	 1	Exchanges air for the first 20 minutes, then remains idle for the next 40 minutes. Repeats every 60 minutes.	Yes	Yes	Yes	Yes
	 2	Executes a high-speed exchange sequence for the selected period of one, two, or four hours.	Yes	Yes	Yes	Yes
	 2	When paired with the Aldes 611228 timer unit, high-speed air is exchanged during its countdown interval.	Yes	Yes	Yes	Yes
	 2	Automatically controls the level of relative humidity by activating the high-speed air exchange when the humidity level exceeds the selected setpoint.	Yes	Yes	Yes	Yes

### Installing the 20/40/60 Minute Timer (P/N 611228)

This controller provides the ventilation unit with high-speed exterior exchange for the following durations:

- 20 minutes
- 40 minutes
- 60 minutes



20/40/60 Timer  
(P/N 611228)

A service box is recommended when installing the timer switch.

1. Run a 3-conductor low-voltage (24V) wire through the wall until it reaches the HRV/ERV.
2. Connect each wire to the timer switch according to its respective color.
3. Connect the 3 wires to the HRV/ERV's terminal block according to their colors.
4. Screw the backside of the control panel to the wall. Use the mounting screws to secure the top section into place.

## Installing the Speed Control (P/N 611229)

This controller provides the ventilation unit with 4 modes of operation:

- Intermittent mode; successive cycles, low-speed 20-min exchange, 40-min stop mode or recirculation
  - Low-speed exterior exchange mode
  - High-speed exterior exchange mode
  - Stop mode or recirculation (indicator lights are off)
1. Run a 4-conductor low-voltage (24V) electrical wire through the wall until it reaches the HRV/ERV.
  2. Connect each wire to the control's terminal block according to its respective color.
  3. Connect the 4 wires to the HRV/ERV's terminal block according their colors.
  4. Screw the backside of the control panel to the wall. Use the mounting screws to secure the top section into place.



Speed Control  
(P/N 611229)

## ZRT VentZone® Systems

VentZone® Systems by Aldes combine model ZRT demand-controlled zone register terminals and Heat Recovery Ventilators (HRV) or Energy Recovery Ventilators (ERV) to create the most advanced home ventilation solution. Zone Register Terminals (ZRT) replace individual fans or static grilles, which control the fan so that areas are only ventilated as desired. Also known as demand-controlled ventilation, controlling the airflow on a zone-by-zone basis saves energy and reduces the load on heating and cooling systems.

Each ZRT is fitted with a self-balancing constant airflow regulator that allows controlled amounts of continuous IAQ ventilation when the damper is closed. The primary flow

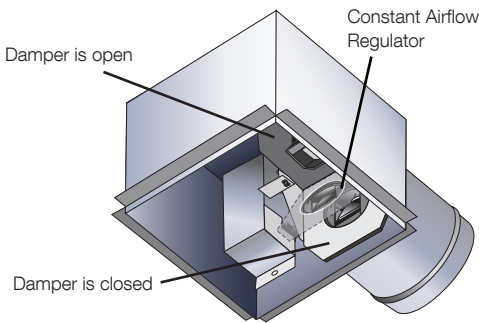

damper opens when called upon by any switch, timer, dehumidistat, or occupancy sensor. Once the damper is opened, the ZRT signals the HRV or ERV to boost speed and airflow from the open ZRT, making it ideal for residential bathroom ventilation.

Aldes VentZone® Zoned IAQ with Heat and Energy Recovery Kits include a Standard Residential Series Heat Recovery Ventilator (HRV) or Energy Recovery Ventilator (ERV) and a combination of Zone Register Terminals (ZRT®) for continuous IAQ exhaust and on-demand boost exhaust during bathroom occupancy.

Aldes VentZone® Zoned IAQ with Heat and Energy Recovery Kits include a Standard Residential Series Heat Recovery Ventilator (HRV) or

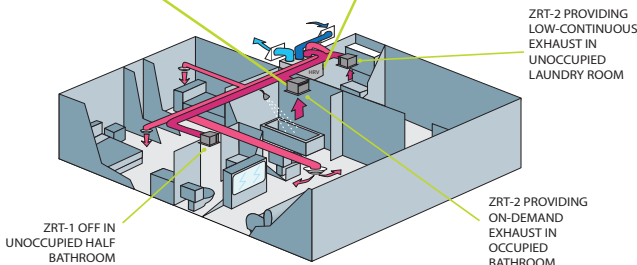
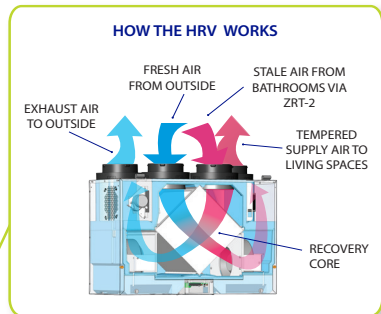
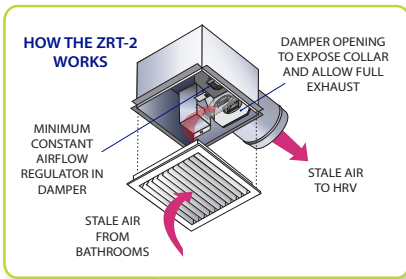

### Getting Started

Before installing your ventilator, the unit must be configured to operate in SLAVE mode (see page 20). A maximum of two ZRTs are recommended to be connected to the H/ERV.

Depending on selection, the ZRTs will be designed to operate on 120V power or 24V power provided by the ventilator itself. If you are not certain what you have, this can be easily determined by the color of the wires on the ZRTs. All ZRTs will have one green (ground) and two red (end switch) wires. The other two wires are black (120V) or yellow (24V).

ZRTs operating on 120V will require installation by a certified electrician. Low-voltage, 24V units can be installed by anyone with basic wiring knowledge. If you are not comfortable with this, please contact a local contractor for installation assistance.

### Installing the Ventilator

For installation details on your HRV/ERV, please refer to page 17 Section "Mounting the Unit."

### Installing the Zone Register Terminal to the Ventilator

VentZone® kits provided with 24V ZRTs are designed to be powered completely through the ventilator. Use of the 20/40/60 Minute Timer (P/N 611228) is recommended to prevent over ventilation and/or frost damage to the heat exchanger in cold climates.

The basic VentZone® System is designed to provide a low volume continuous rate of ventilation, with intermittent boost through the selected ZRT.

To enable the low speed mode, place a jumper between connections 1 and 3 on the terminal block as shown below.

*Note: A switch can be placed on this to activate and deactivate ventilation without interfering with ZRT operation. This can be ideal for times of the year when opening a window is preferred or the home is empty for extended periods of time, i.e. disabling the ventilator for seasonal homes to lower electric costs when unoccupied.*

Each ZRT will require its own timer. Connect as illustrated below.

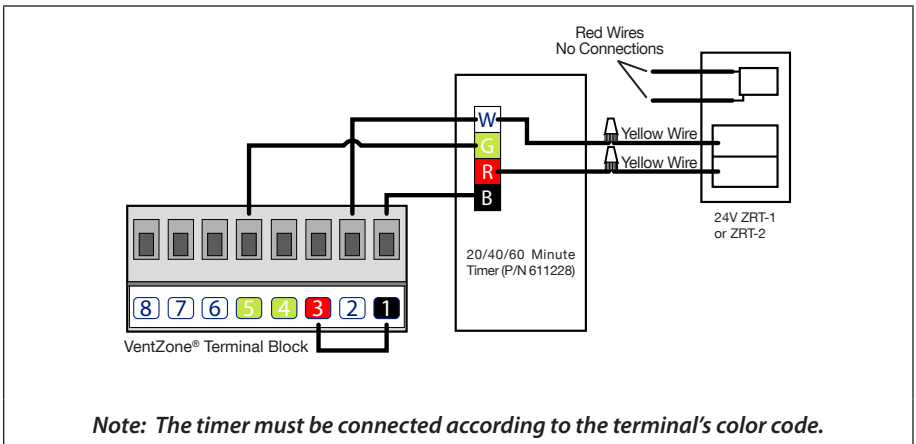



### **Adding Accessories to the VentZone® System**

Due to the operation of the VentZone® System, most Aldes controllers cannot be utilized.

## **V. MEASURING & BALANCING AIRFLOW**

### **Measure and Balance**

The installer must measure and balance the airflow brought in from the outside and the exhaust airflow so that the difference between the two is less than 10% of the maximum airflow. This airflow balance is especially important in homes using a combustion device or in those located in areas where the ground emits radon.

If the airflows are not properly balanced, then:

- The HRV/ERV may not operate at its maximum efficiency
- A negative or positive air pressure situation may occur in the house
- The unit may not defrost properly

Excessive positive pressure may drive moist indoor air into the external walls of the building, where it may condense (in cold weather) and degrade structure components. It may also cause key holes to freeze up.

Excessive negative pressure may have several undesirable effects. In some geographic locations, soil gases such as methane and radon gas may be drawn into the home through basement/ground contact areas. Excessive negative pressure may also cause the backdrafting of vented combustion equipment.

### **CAREFULLY READ THE WARNINGS IN THE SECTION “PRECAUTIONS & GUIDELINES” ON PAGE 5.**

Fresh and stale airflow can be measured and balanced by two methods: Door-Port Balancing or In-Duct Balancing

### **Door-Port Balancing (E80-HRG,-HRX only)**

Door-port balancing is used to determine and adjust the airflow rates of the supply and exhaust air streams by measuring the static pressure loss across the HRV/ERV core. The recommended tool for this procedure is a differential pressure gauge (with a 0.0-0.25 in. w.g. range) or a digital manometer.

**Note:** *The airflow chart on the door of the unit is for use with the filters that come with the unit. If other filters are used, in-duct measurements of airflow may be made using pitot tube, airflow probes, or hot-wire thermal anemometer as described in later sections.*

## Door-Port Balancing – Measuring Airflow

1. Finish sealing the ductwork system.
2. Make sure all the HRV/ERV components are in place and functioning properly.
3. Prepare the pressure gauge by mounting it according to manufacturer's instructions and zeroing the gauge.
4. Prepare the HRV/ERV and select the operating speed. For most installations, measuring at high speed permits a more accurate reading, and the system will normally remain in balance at lower speeds.
  - a. If there are dynamic elements in the duct that react to changing pressures, the HRV/ERV should be balanced at the speed it is expected to operate most of the time. **Example: If the ducting system includes zone dampers or Zoned Register Terminals (ZRT®), it must be balanced at a speed lower than normal operation. If balanced at high speed, the HRV/ERV will not be in balance at the lower speeds due to the operation of the constant airflow regulators incorporated in the ZRTs.**
5. If the HRV/ERV is ducted to the forced-air HVAC system, turn that blower on high speed as well.
6. Airflows in branch lines to specific areas of the house should be adjusted first prior to balancing the unit. A smoke pencil used at the grilles is a good indicator of each branch line's relative airflow.
7. Locate the 4 ports on the door of the HRV/ERV and remove the plugs.
8. Refer to the drawings below and connect the tubing from the pressure gauge to the respective door ports to the outdoor air and supply air ports.

**Note: The geometry may differ from one model to another.**

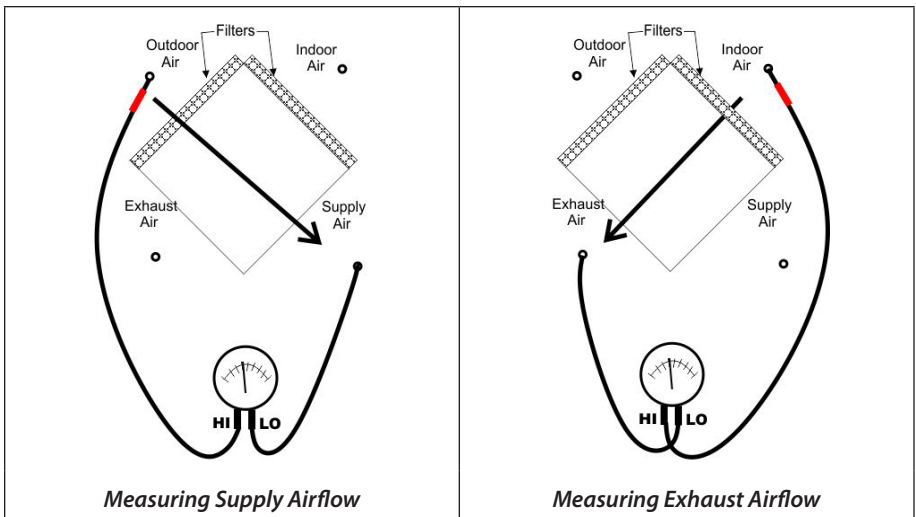

1. Record the pressure measurement.
2. Refer to the reference chart on the unit that shows the pressure readings versus the corresponding supply airflows. Record this airflow.
3. Connect the tubing to the corresponding indoor air and exhaust air door ports using the diagram above.
4. Repeat steps 6-8 for the exhaust airflow.
5. Then follow the procedure in the following section.

**Note:** Generally, the best performance of the HRV/ERV is achieved when the airflows are within 10% of each other. The airflow balance may be set for balanced airflow, slightly positive or slightly negative, depending on the particular needs of the home. Often a slight positive pressure is desired to help resist backdraft from combustion devices, radon gas, or drawing air from an attached garage.

### Balancing Airflow and Adjusting Motor Speed – FLEXControl User Interface

Once the airflow is measured, with the tubes still connected, turn down the higher airflow to match the lower airflow to achieve balanced airflow. This is done by adjusting the two potentiometers on the HRV/ERV, one for Supply (FAN IN) and one for Exhaust (FAN OUT). To balance airflow, follow steps 1-5 below. To adjust the motor speed, activate the unit on HIGH SPEED by using the activation button, then follow the same steps 1-5 below.

**Note:** It is generally preferable to perform the adjustment with the unit on HIGH SPEED. The LOW SPEED is approximately 60% of the high speed. ZRT VentZone® must be balanced on LOW SPEED. See page 35.

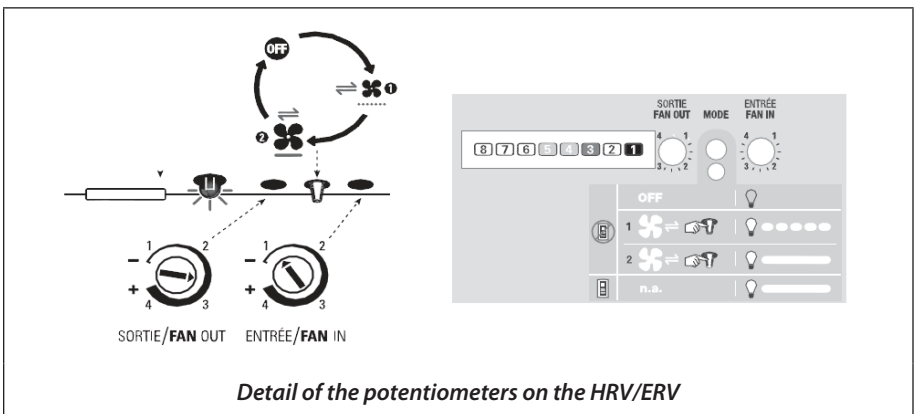



1. To Adjust SUPPLY (FAN IN) air stream: Connect the tubes like the diagram below shows, then turn the FAN IN potentiometer to the desired level.
2. Adjust the EXHAUST (FAN OUT) air stream: Connect the tubes like the diagram below shows, then turn the FAN OUT potentiometer to the desired level.

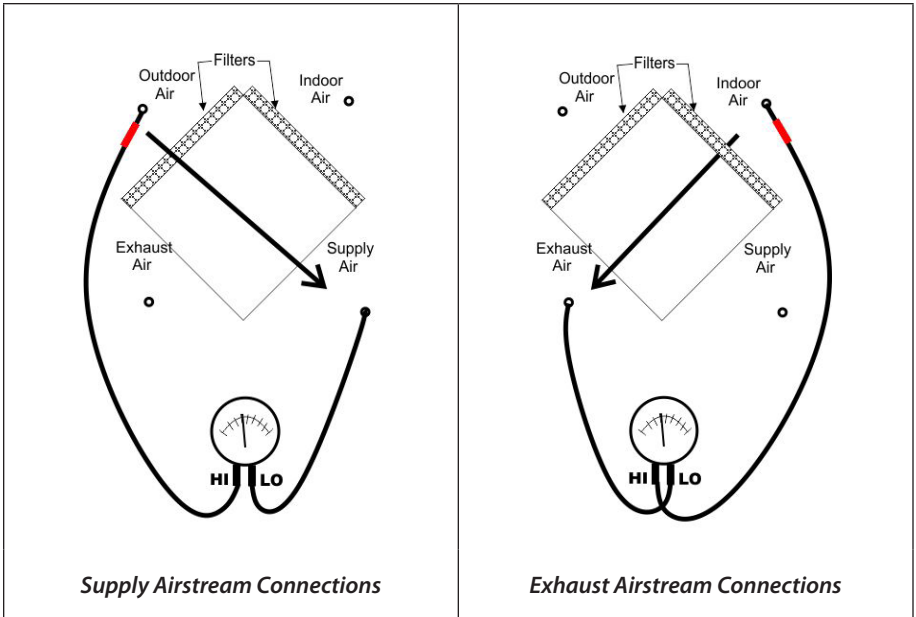

3. Repeat the airflow measurement and adjustment until the desired supply and exhaust airflows are obtained.
4. Remove all tubing and replace the plugs in the door ports.

## Sample Door-Port Balancing Example

The static pressure reading across the fresh air is 0.19 in. w.g., indicating an airflow of 187 CFM. The reading for the stale air is 0.14 in. w.g., indicating the exhaust airflow is 170 CFM. The supply airflow should be adjusted to about 170 CFM (see section “Balancing Airflow and Adjusting Motor Speed” on page 32) until the pressure reading is about 0.17 in. w.g.

Model no :		# Série / Serial :		Date :	
		0			
Pression / Pressure		Débit / Flow			
Pa	inH <sub>2</sub> O	Frais / Fresh	Vicié / Stale		
		PCM / CFM	PCM / CFM		
10.0	0.04	48	59		
12.5	0.05	59	72		
15.0	0.06	70	85		
17.5	0.07	80	96		
20.0	0.08	90	108		
22.5	0.09	100	119		
25.0	0.10	110	130		
27.5	0.11	119	141		
30.0	0.12	128	151		
32.5	0.13	137	161		
35.0	0.14	146	170		
37.5	0.15	155	180		
40.0	0.16	163	189		
42.5	0.17	171	199		
45.0	0.18	179	207		
47.5	0.19	187	216		
50.0	0.20	195	224		
52.5	0.21	203	233		
55.0	0.22	211	241		
57.5	0.23	218	249		
60.0	0.24	226	257		
62.5	0.25	233	265		
65.0	0.30	268			
67.5	0.31				
70.0	0.32				
72.5	0.33				
75.0	0.34				
77.5	0.35				
80.0	0.36				
82.5	0.37				
85.0	0.38				
87.5	0.39				

Example 1: Balancing using the provided airflow chart

## In-Duct Balancing

In-Duct Balancing consists of finding the average velocity in the duct, then multiplying by the area to obtain airflow.

Use this method with higher efficiency filters, or with models H/E130, H/E80-HF,-HR

There are three in-duct balancing methods:

1. Pitot tube and manometer or digital differential pressure gauge to measure the velocity.

**Note:** Pitot tubes are not recommended for velocities below 400 FPM.

2. Airflow station or probe in the supply and exhaust ducts to measure the average pressure, then use a conversion chart (provided by the flow station manufacturer) to convert to velocity then to airflow.

**Note:** Compared to a pitot tube measurement, the airflow station or airflow probes provide a higher pressure reading, making it possible to read very low airflows. To get the most accurate results, select a differential pressure gauge that will give

*nearly a full-scale reading when the HRV/ERV is operating at high speed. Follow the instructions supplied with the sensing units regarding proximity to elbows, dampers, etc.*

- Hot-wire thermal anemometers provide a direct air velocity reading.

## Balancing in a VentZone® system

The ZRT-2 models are equipped with Aldes Constant Airflow Regulators to automatically regulate airflow from each terminal while the ventilator is on and the ZRT is unpowered. When the ZRT is powered open, the damper opens and the high speed mode is enabled at the ventilator. This will boost airflow at the powered ZRT, while the self-balancing regulators maintain the set flow rate at the unpowered ZRTs.

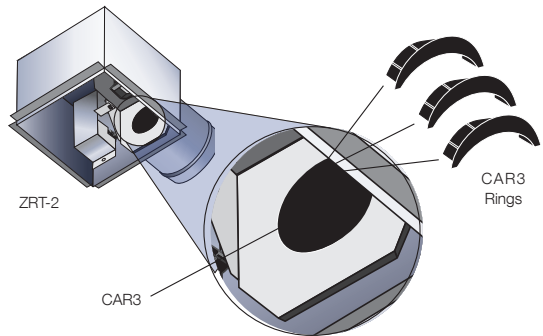

### Balancing the System

- Finish sealing the ductwork system.
- Set all ZRTs to desired flow rate. Start by determining the required minimum ventilation rate for each ZRT. Larger areas, or areas frequently used, may require additional airflow in order for the system to perform as desired.
  - The CAR3 : has three optional airflow rates; 10, 20, and 30 CFM. The default setting is 10 CFM. To adjust the airflow rate, there are two clips in the constant airflow regulator, which can be removed to increase the flow rate. Removing one clip will increase from 10 to 20 CFM, and removing the second clip will increase the airflow rate to 30 CFM. These rates can be changed at any time after installation is complete, but rebalancing may be required.
  - MR-Modulo : Remove the MR-Modulo from the damper and twist the adjustment ring with the desired airflow is reached. Replace MR-Modulo.
  - MR-Mono : The airflow cannot be adjusted, continue to step 3.
- Make sure all HRV/ERV components are in place and functioning properly. All ZRTs should be OFF and in the closed position.
- Prepare the HRV/ERV and select the operating speed. VentZone® Systems typically balance in LOW SPEED

**Note:** *Due to the use of the constant airflow regulators, some effort needs to be taken to balance the exhaust air rate to the operating point of the regulators.*

- LOW SPEED can be activated by pressing the Mode Indicator button until the light is solidly illuminated.



**Note: The light will be solid when any accessories are attached or controlling the HRV/ERV. To avoid this, disconnect the Accessories Terminal Block.**

6. Locate the 4 ports on the door of the HRV/ERV and remove the plugs.
7. Refer to the drawings on page 30 and connect the tubing from the pressure gauge to the respective door ports for the indoor air and exhaust air connections. See "Measuring Exhaust Airflow" on page 30.

**Note: The geometry may differ from one model to another.**

8. Locate the blower potentiometers and adjust the FAN OUT dial to the highest setting. This can be audibly heard as the unit will be loudest at this operating condition.
9. To determine the operating threshold of the exhaust regulators, slowly adjust the FAN OUT dial until the reading on the manometer gauge starts to drop noticeably.

**Note: Slight fluctuation is normal, with the needle moving up or down as the system pressure changes.**

10. When the operating threshold is determined, adjust the speed to be just above the point where the pressure starts to drop off.
11. Record this pressure measurement.
12. Refer to the reference chart on the unit that shows the pressure readings versus the corresponding supply airflows. Record this airflow.

**Note: This airflow should be very close to the sum of the set points of the regulators in the ZRTs. If three ZRTs are all set to 10 CFM, the total measured airflow should be close to 30 CFM. Some discrepancy is normal.**

13. Follow the procedure in "Balancing Airflow and Adjusting Motor Speed" on page 33.

**Note: The "Balancing Airflow and Adjusting Motor Speed" Section will have you balance the higher airflow to the lower airflow in order to achieve balance between supply and exhaust air streams. With the VentZone® System, the exhaust should be the lower CFM air stream, so you will be balancing the supply to the exhaust per these steps.**

## VI. MAINTENANCE

### WARNING:

In order to prevent electric shock when cleaning or servicing, unplug the HRV/ERV before servicing.

**Homeowners:** It may be preferable to have a qualified service technician complete your HRV/ERV general maintenance.

## General Maintenance

### WARNING: ALWAYS UNPLUG THE DEVICE BEFORE PERFORMING MAINTENANCE

**To access internal components:** Remove or lift up the unit door. Remove the unit door by opening the latch and lifting the door off the hinges.

#### 1. Air Filters

- a. With door removed or lifted up, remove the filters.
- b. Follow the cleaning schedule and procedure for your unit's filter type.
- c. See the table below to determine the filter that comes standard with your unit and what replacement filter options are available from Aldes.

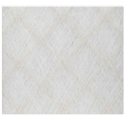
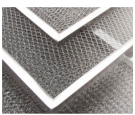
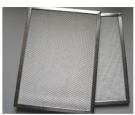
FILTER TYPE		
MERV 6 or 8	Aluminum	High-Efficiency <sup>†</sup>
		
USE: Trap impurities	USE: Trap impurities and grease	USE: Trap impurities and pollen; use on supply side only
CARE: clean seasonally with water and detergent spray	CARE: Clean 2-3 times/year with water and mild detergent	CARE: Replace each season

<sup>†</sup> MERV 13 Equivalent

#### 2. Recovery Core

- a. With door removed or lifted up, remove the filters. Next remove the recovery core by gently pulling it from the device. Wear gloves to protect your hands from the core's sharp edges.
- b. Follow the cleaning procedure for your unit's core type:

**Warning:** take care when opening or removing the unit's door, in case the core was not securely installed previously and could fall out.

RECOVERY CORE TYPE	
HRV	ERV
Soak in warm soapy water, rinse, and allow dry thoroughly	Gently vacuum the surface of the core

- c. To properly install the clean core:
  1. Mount the bottom flange of the core guide into the bottom H channel approximately 1/4" (6mm).
  2. Mount the left or right side flange of the core guide approximately 1/4" (6mm) followed by the other side.
  3. Mount the top flange of the core guide into the top H channel approximately 1/4" (6mm).
  4. When all four corners are in place and the core is straight and even, push hard in the center of the core until the core stops on the back of the cabinet.



3. Cabinet (twice a year)  
 With the door removed, wipe down the inside of the cabinet with a damp cloth to remove any dust or debris.  
**ONLY USE WATER. DO NOT USE PRODUCTS CONTAINING SOLVENTS. DO NOT USE HOUSEHOLD CLEANING PRODUCTS.**  
 Wipe the interior with a dry cloth.
4. Condensate Drain - Clean once a year  
 Inspect drain line, drain spout, and "P-Trap" for blockages, mold or kinks.  
 Flush with warm, soapy water.  
 Replace if worn, bent, or cannot be cleaned. See page 18 Section "Drain Connections (HRV Models)" for installing condensate drains.
5. Duct Work (as needed)  
 The ductwork running to and from the HRV/ERV may accumulate dirt.  
 Wipe and vacuum the ductwork once every year.  
 It may be preferable to contact a company that specializes in duct cleaning.
6. Exterior Wall Hoods  
 If exterior hoods are in an accessible location, make sure they are not restricted by patio furniture, plants, snow or other obstructions. All ductwork should be cleaned every 3 years
7. Motors and fans (No maintenance needed)

**After Performing Maintenance:** Slide the core and filters back into the unit. Re-attach the door to its hinges and latch the handle. Plug the unit into its power source.

## Replacement Filters

Part Number	Filter Type	Applicable Models	Quantity
612415	MERV 6*	H/E80	2
683961	MERV 8	H/E130	2
612407	High Efficiency†	H/E130	2
612405	Washable Foam*	H/E130	2

\* Filter type is standard with unit † MERV 13 Equivalent

## Technical Assistance

**Canada call 1-800-262-0916**  
**Monday-Friday, 8 a.m. to 5 p.m. Eastern Time**  
**USA call 1-800-255-7749**  
**Monday-Friday, 8 a.m. to 5 p.m. Eastern Time**

# TROUBLESHOOTING

<i>Symptom</i>	<i>Possible Causes</i>	<i>Solution</i>
HRV does not power up (indicator light on the unit is not lit up)	<ul style="list-style-type: none"> <li>• Unit is not plugged in</li> <li>• No power to outlet</li> <li>• Defective fuse</li> <li>• HRV control board may be defective</li> </ul>	<ul style="list-style-type: none"> <li>• Make sure unit is plugged in</li> <li>• Test outlet with another device</li> </ul>
HRV is not responding to a wall control	<ul style="list-style-type: none"> <li>• Wall control is set to OFF.</li> <li>• Terminal block is loose.</li> <li>• Bad low voltage connection or interruption (due to a nail in the wall, for example).</li> </ul>	<ul style="list-style-type: none"> <li>• Ensure that the wall control has power (screen or LED lights illuminate).</li> <li>• Check wiring from HRV to wall control for open/short circuit.</li> <li>• Ensure that the terminal block is well seated in the HRV</li> </ul>
The HRV is producing excessive vibrations	<ul style="list-style-type: none"> <li>• Dirt on the fan wheels</li> <li>• Malfunctioning motor</li> </ul>	<ul style="list-style-type: none"> <li>• Call contractor to perform HRV servicing</li> </ul>
Poor airflows	<ul style="list-style-type: none"> <li>• Hoods or grilles are obstructed</li> <li>• The HRV filters are clogged</li> <li>• Obstruction in the heat-recovery core</li> <li>• Poor power supply</li> <li>• Ductwork is restricting airflow to/from HRV</li> <li>• Speed is set to Low</li> <li>• HRV is not balanced.</li> </ul>	<ul style="list-style-type: none"> <li>• Ensure that the outdoor exhaust and intake hoods are free of obstructions</li> <li>• Clean or replace the filters</li> <li>• Clean the heat-recovery core</li> <li>• Use wall control to increase the speed of the HRV</li> <li>• Call your contractor to check supply voltage and/or balance the HRV airflows .</li> </ul>
Supply air feels cold	<ul style="list-style-type: none"> <li>• Outdoor temperature is extremely cold.</li> <li>• Supply grille is located close to occupants</li> <li>• HRV automatic defrost function is not working</li> <li>• Unit is in free cooling mode</li> </ul>	<ul style="list-style-type: none"> <li>• Locate the supply grilles high on the walls, or in the ceiling with a diffuser.</li> <li>• Reduce the operating speed of the HRV</li> <li>• If supply air is ducted through the furnace plenum, ensure that the HRV and furnace fan are interlocked.</li> <li>• Disable free cooling (see page 24 or refer to the 611242-FC wall control user guide).</li> </ul>
Wall Dehumidistat is not working	<ul style="list-style-type: none"> <li>• The wall control is not set properly</li> <li>• Outdoor RH is higher than the control setpoint</li> <li>• Bad low voltage connection or interruption (due to a nail in the wall, for example).</li> </ul>	<ul style="list-style-type: none"> <li>• For control 611242-FC, ensure that the AUTO mode is selected and the target RH level is below the outdoor RH.</li> <li>• For control 611227, ensure the wall control is not OFF and that the target RH setpoint is below the outdoor RH.</li> <li>• Check wiring from HRV to wall control for open/short circuit.</li> </ul>

<p>Indoor air is too dry (note: an HRV is not a dehumidifier, however by exchanging indoor air with outdoor air, it can reduce excess indoor humidity if the outdoor air is drier).</p>	<ul style="list-style-type: none"> <li>• Dehumidistat wall control is set too low</li> <li>• HRV operating speed is too high</li> <li>• Improperly balanced HRV</li> </ul>	<ul style="list-style-type: none"> <li>• Increase setpoint of dehumidistat.</li> <li>• Operate HRV at low speed.</li> <li>• Call a contractor to balance the HRV airflows</li> <li>• Add moisture to air with a humidifier</li> </ul>
<p>Indoor air is too humid and/or condensation is forming on the inside of windows</p>	<ul style="list-style-type: none"> <li>• Dehumidistat is set too high</li> <li>• Obstructed supply or exhaust grilles</li> <li>• Not enough exhaust capacity near source of moisture</li> <li>• HRV operating speed is too low</li> </ul>	<ul style="list-style-type: none"> <li>• Decrease the setpoint of the dehumidistat.</li> <li>• Reduce sources of indoor humidity (steam, wet clothes, plants, firewood) and excessive temperature</li> <li>• Operate HRV at high speed or use continuous ventilation (not intermittent or ECO modes).</li> </ul>
<p>Frost is forming on the HRV and/or ducts connected to the HRV</p>	<ul style="list-style-type: none"> <li>• HRV is not balanced</li> <li>• HRV automatic defrost function is not working</li> <li>• Leaky vapour barrier around insulated duct</li> <li>• Hole in flexible duct</li> </ul>	<ul style="list-style-type: none"> <li>• Tape and seal all joints and duct connections</li> <li>• Repair any holes in flexible duct</li> <li>• Call contractor to balance the HRV and verify defrost functionality</li> </ul>
<p>Water is accumulating in the bottom of the HRV</p>	<ul style="list-style-type: none"> <li>• Obstructed drain line or drainage pan.</li> <li>• Improper connection of drain</li> <li>• HRV is not level</li> </ul>	<ul style="list-style-type: none"> <li>• Remove obstructions or kinks in the drainage tube</li> <li>• Open HRV and check for material blocking the drainage holes.</li> <li>• Adjust the mounting chains or bracket so that the HRV is level</li> </ul>
<p>HRV stays in high speed after the 20/40/60 minute timer cycle is complete</p>	<ul style="list-style-type: none"> <li>• One or more extraction ZRT dampers remains open</li> <li>• Timer in another bathroom is still active</li> <li>• Dehumidistat detected excess humidity while timer was on</li> <li>• Automatic defrost cycle is running based on cold outdoor temperature</li> </ul>	<ul style="list-style-type: none"> <li>• Check if wall control is set to a high speed mode (dehumidistat, high-occupancy, etc...)</li> <li>• Check the bathroom exhaust terminals to ensure that the dampers are fully closed.</li> <li>• Wait a maximum of 30 minutes for defrost cycle to complete.</li> </ul>



## VII. WARRANTY

### What's Included

The warranty period for residential ventilation units begins on the date of manufacture indicated on the serial number (modelYYMMXXX where YY is the year and MM the month).

The Heat Exchanger has a warranty which is dependent upon its core type:

CORE TYPE	WARRANTY
Polypropylene (HRV)	Limited Lifetime
High-Latent-Transfer Material (ERV)	Limited 5-year
ALL OTHER COVERED COMPONENTS	
Limited 5-year	

The Seller warrants to the Purchaser that any equipment manufactured by it and bearing its name plate, to be free from defects in material and workmanship, under proper and normal use and service as follows: If, at any time within the warranty of the product (see individual specifications), the Purchaser notifies the Seller that, in his opinion, the equipment is defective, and returns the equipment to the Seller's originating factory prepaid, and the Seller's inspection finds the equipment to be defective in material or workmanship, the Seller will promptly correct it by either, at their option, repairing any defective part or material or replacing it free of charge and return shipped lowest cost transportation prepaid (if Purchaser requests premium transportation, Purchaser will be billed for difference in transportation costs). If inspection by the Seller does not disclose any defect in material or workmanship, the Seller's regular charges will apply. This warranty shall be effective only if use and maintenance is in accordance with our instructions and written notice of a defect is given to the Seller within such period.

This warranty is exclusive and is in lieu of any other warranties, oral or implied, specifically, without limitation, there is no warranty of merchantability or fitness for any purpose. The liability of the Seller is limited to the repair or replacement of materials or parts as set forth.

**Limitation of Liability:** The Seller shall not be liable for any claim or consequential or special loss or damage arising or alleged to have arisen from any delay in delivery or malfunction or failure of the equipment. The Seller's liability for any other loss or damage arising out of or connected with the manufacture or use of the equipment sold, including damage due to negligence, shall not in any event exceed the price of the equipment supplied by Seller.

### How to File a Warranty Claim

Before removing a defective product, contact Aldes for technical assistance.

If a part is proved defective, it will be replaced with another part or repaired according to the company's assessment.

Before returning a defective product for repair, contact Aldes customer service to obtain a Return Materials Authorization (RMA). Send the defective part postage paid to the address below based on your residence. It will be returned to you postage paid.





American Aldes Ventilation Corporation  
4521 19th St. Ct. E.  
Suite 104  
Bradenton, FL 34203  
1-800-255-7749  
[www.aldes-na.com](http://www.aldes-na.com)

Aldes Canada  
100 Rue Carter  
Saint-Leonard d'Aston, QC J0C 1M0  
1-800-262-0916  
[www.aldes-na.com](http://www.aldes-na.com)